



PRODUCT
CATALOGUE

Transforming
Airfield Lighting



Thomas & Betts

A Member of the ABB Group

Company Profile

Thomas and Betts Limited a Member of the ABB Group is a leading designer, manufacturer and owner of the **AMERACE®** most trusted and proven AGL brand of **Airfield Lighting Series Isolation Transformers, Connector Kits and Cable Assemblies**. The high quality products are incorporated in many major airports around the world for over 100 years. The Sales/Marketing/Engineering/Customer service is located in Whitby / Burlington, Ontario, Canada and manufactures all its products in Ormond Beach, Florida - USA.



Ontario, Canada (Sales/Engineering)



Ormond Beach, Florida USA (Manufacturing)

Quality & Environmental Policy

To consistently provide high quality products, we employ a formal documented Quality Assurance and Environmental Management System. We supplement this with third party certification approvals for both our quality/environmental management system and specific products.

QUALITY / ENVIRONMENTAL CERTIFICATION ISO 9001 / 14001

CERTIFICATE OF REGISTRATION
This is to certify that **Thomas & Betts Limited** 120, Avenue Thomas, Scarborough/Richmond, Ontario, L2X 2M0 Canada Refer to Attachment to Certificate of Registration dated August 22, 2012 for additional certified sites operates a **Quality Management System** which complies with the requirements of **ISO 9001:2008** for the following scope of registration: The design, manufacture and distribution of electrical components, cable trays and emergency lighting systems.

Certificate No.: CERT-0072008
File No.: 13362-000208
Issue Date: August 22, 2012

Original Certification Date: October 31, 2002
Current Certification Date: November 23, 2012
Certificate Expiry Date: November 23, 2015

SAI GLOBAL

CERTIFICATE OF REGISTRATION
This is to certify that **Thomas & Betts Limited** 120 Nashdown Road, Scarborough, Ontario M1V 2W3 Canada operates an **Environmental Management System** which complies with the requirements of **ISO 14001:2004** for the following scope of registration: Design and manufacture of AGL Series transformers and related connectors for applications such as airport runway marking light systems and connectors for street lighting.

Certificate No.: CERT-0072000
File No.: 10881-01
Issue Date: August 16, 2013

Original Certification Date: October 5, 2010
Current Certification Date: October 4, 2013
Certificate Expiry Date: October 3, 2016

SAI GLOBAL

PRODUCT 3rd PARTY CERTIFICATION CSA / ETL

REVISION DATE: **October 23, 2012**
ORIGINAL ISSUE DATE: **August 20, 2008**
Reclassification Date: **June 2012**
An Activity Sponsored and Administered by **Intertek**

Manufacturer: **Thomas & Betts (Ontario) Ltd.**
120, Nashdown Road,
Scarborough, ON M1V 2W3 Canada

AIRPORT LIGHTING EQUIPMENT CERTIFICATION PROGRAM
CERTIFICATE OF CONFORMANCE

The product identified below is hereby approved for being in the next issue of the Ontario Aviation Certification Register. The Register is published in the Ontario Aviation Certification Equipment Specifications Manual. It is the responsibility of the manufacturer to ensure that the product continues to meet the requirements listed in the Register and to report any changes to the Register Administrator. The results of each test, accompanied by signed documents by the testing organization, are available to the manufacturer. This certificate is not valid for a product recalled with non-CER replacement parts or non-production components.

Manufacturer	Type	Model	Approval Program	Manufacturer's Listing Number
A Division of Thomas & Betts	L-821-H	48	A & M B	TA00000-01
				October 13

1. This Equipment requires continuing validation in accordance with the requirements of AC 1005345-03.
2. Product tested and Report Issued by: **Intertek - Ontario, Canada**
3. Report No. **04-03-11-00** (30 Date of Report: **12/08/08, 8/2011**)

Approved for Contribution by: *[Signature]*
NOTE: PLEASE REVIEW AND ADVISE **POWERTEST.COM** AT **POWERTEST@AMERICANET.COM** IF DATA ARE SHOWN NEED TO BE CORRECTED.

Intertek is a Division of P.E. Engineering Administration
Date: **February 24, 2012**

Form AL-10300

Certificate of Compliance

Certificate: 2012412 (LR 100164)
Model Contract: 17152

Project: 7010776
Issued to: **Thomas & Betts (Ontario) Ltd.**
120 Nashdown Rd
Scarborough, ON M1V 2W3
Canada
Attention: Herman Dijkstra

Date Issued: January 22, 2012

The products listed below are eligible to bear the CSA Mark shown

Issued by: **SAI Global**

CLASS #1116 - TRANSFORMERS-Fluorescent

Some Catalogue Trademarks for Airport Lighting, TPL 170-171 recognized, with associated test and conformity conditions, N1, available

CSA #	Voltage, V	Power/Wattage	Frequency, Hz
142010000	120V	400VA	60
142010000	240V	400VA	60
142010000	240V	400VA	50/60
142010000	240V	400VA	60
142010000	120V	400VA	60
142010000	120V	400VA	50/60
142010000	120V	400VA	60
142010000	120V	400VA	60
142010000	120V	400VA	60
142010000	120V	400VA	60

Product Index Guide for Typical AGL Series Circuit

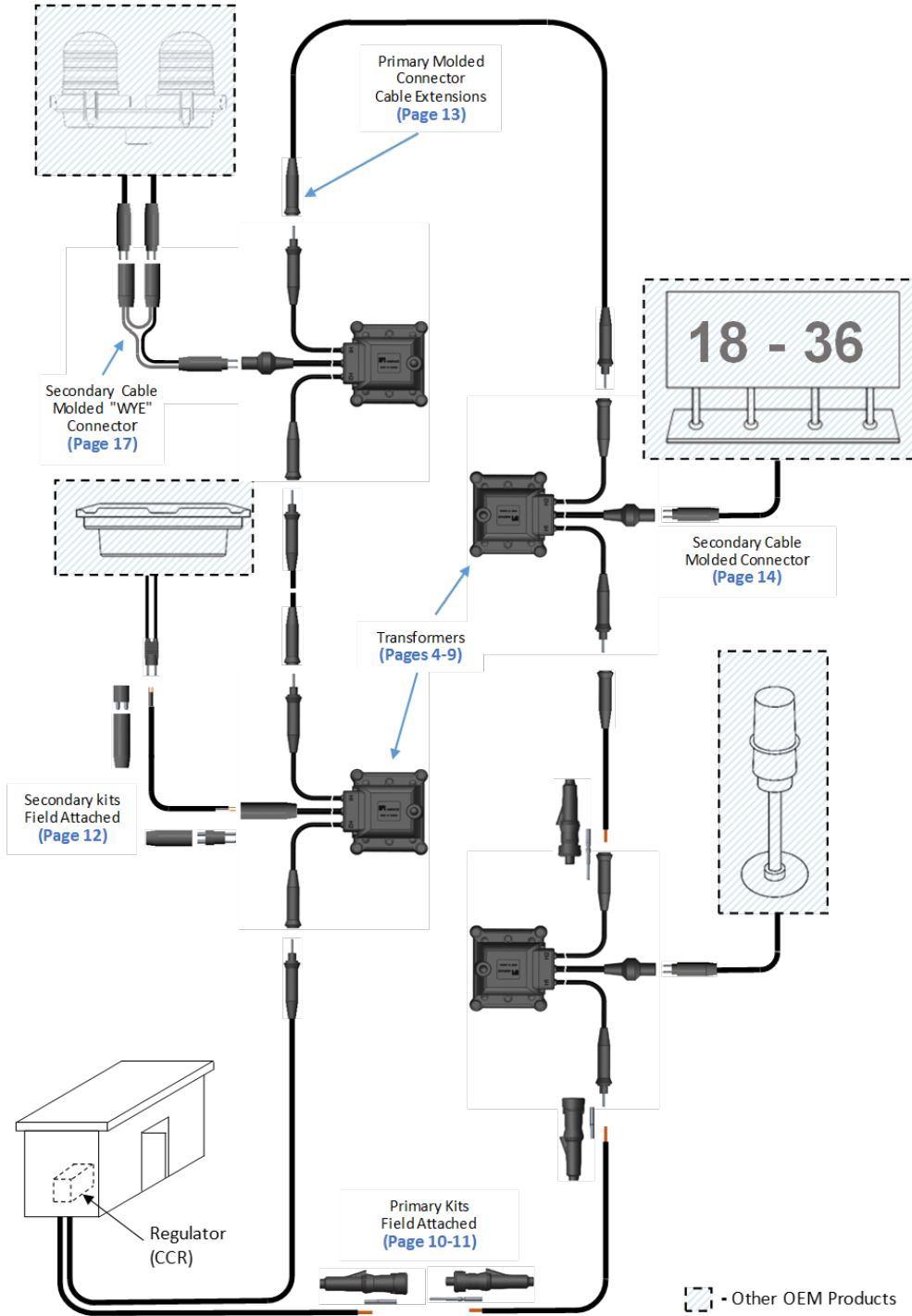

Series Isolating Transformers

GENERAL CONSTRUCTION SPECIFICATIONS

Winding	Magnet wire on a plastic bobbin, specifically designed to electrically isolate the primary and secondary windings for maximum safety.
Core	Flat laminations (E&I) of high grade grain oriented silicon steel for a long stable life.
Encapsulant	TPR rubber (also known as TPV, TPE) Much higher dielectric strength and lower water absorption than older materials such as epoxy, neoprene, or polychloroprene. Minimal swelling in the presence of hydrocarbons, unlike neoprene, polychloroprene, etc.
Encapsulation process	Injection molding for maximum consistency of encapsulation, yielding exceptionally low leakage currents. Vacuum drawing prior to injection prevents air pockets inside. A far superior process to compression or transfer molding, or pouring.
Primary cables	Wire is AWG #8 (8,3 mm ²) Type C TPR Insulated for maximum reliability, 0,6 meter (24") with FAA Class A Style 2 plug and Style 9 receptacle connectors
Secondary cable	Cable 2/12 AWG (3,3 mm ²) or 2/14AWG (2.1 mm ²) TPR Insulated ; length 1,2 meters (48") with FAA Class A Style 8 or Style 7 receptacle connector
Connector pins and sockets	1/2 hard brass ; Tin plated for corrosion resistance
Material compatibility	Transformer body, cables, and connectors are all molded of TPR for perfect bonding.
Water proof	Transformers are designed and manufactured to operate submerged in water indefinitely

ELECTRICAL

Insulation Level	Primary 5000 V RMS; Secondary 600 V RMS
Insulation Resistance	<ul style="list-style-type: none"> • Minimum specification resistance 7500 Megohms (tested hot with 15 kV DC) • Typical measurements : 150,000 Megohms (Much higher than that required by FAA AC L830/831)
Open Circuit Voltages	<ul style="list-style-type: none"> • Less than 3 times the full load RMS value in all sizes, generally much lower, when tested with pure sine waves.
Efficiencies	70% to 95% depending on the power rating (10-500W), higher the wattage higher the eff.
Power Factor	> 0,97 for all
Ratio	Flat response load curves for constant lamp brilliancy and long life
Testing	<ul style="list-style-type: none"> • All units (100%) are hi-potted and their electrical characteristics confirmed • All ratio testing done with the appropriate frequency, 50Hz or 60 Hz, for precision. No "conversion factors" used.
Light Monitoring systems	Compatible with leading manufactures (OEM) of these systems

ENVIRONMENTAL

Operating Temperature Range	-55°C to +65°C
Contaminant resistance	Suitable for areas contaminated with most oils, aircraft fuels, soil acids and alkalis, and de-icing fluids. Resistant to UV exposure and ozone.

APPROVALS/CONFORMANCES/CERTIFICATIONS

- Accepted in most countries of the world: **FAA** (FAA AC150/5345-53), **CSA** (C22.2 No. 180-M1983-1 2009), & **IEC** 61823
- Also complies with STNA (France), ICAO. AGL Standards

INSTALLATION OPTIONS

All types, including above ground, in concrete / other non-metallic pits, in metal cans, or direct buried.



Series Isolating Transformers



FAA Style (NON-EARTHED)



ICAO STYLE (WITH EARTH GROUND)

Amerace manufactures the **world's broadest range of series isolating transformers.**

Some of the options available are:

Nominal Power (Watts) 10/15, 20/25 30/45, 65, 100, 150, 200,250,300, 400, 500

Primary/Secondary current (A) 4, 4.4, 6.6, 8.3, 12, 20 in many single combinations

Frequency (Hz) : 50 or 60

The table below shows several available constructions according to applicable standards or advisory circulars.

Construction	Grounding	Secondary Connector	Primary Connectors?
FAA /BAA compliant	No	Style 7 or 8	Yes
CSA (Canada)	Yes	Style 8	Yes
IEC (International)	Yes/No	Style 7 or 8	Yes
ICAO Style	Yes	Style 7 or 8	Yes
UK Style	Yes	Style 7 or 8	No
UK TISE	Yes	Style 7	No

Don't see what you want here? :

Contact us with your requirements or go to our web site to Create Your Own Transformer.



Airport Equipment
Qualified to
FAA Specification
AC 150/5345-47

Series Isolating Transformers

GENERAL INFORMATION Secondary Connector configurations

- suffix 01
"Tennis Ball"
FAA Style 8

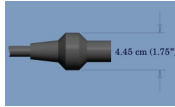

- suffix 10
"Straight"
FAA Style 7



• **Grounded**

transformers :Unlike the FAA, ICAO recommends that each transformer have an earth (ground) connection for one side of the secondary (large socket, white wire). Any Amerace® transformer can be supplied with an earth stud to meet this recommendation. To specify, add the letter G to the catalog number as follows -a TA045666-01 would become a TAG045666-01.

FAA SPECIFICATION L 830 60 Hz *

FAA DESIGNATION	Catalog no.	Rated Watts	Pri/Sec. Amps	Figure (See Page 9)	T Dim. (cm/in.)	Primary Lead Length (cm/in.)	Sec. Lead Length (m/in.)	Weight (Kg.)	Weight (Lb)
L830-1	TA045666-xx	30/45	6.6/6.6	2	8,6 / 3.4	60 / 24"	1.2 / 48"	2,4	5.2
L830-2	TA045266-xx	30/45	20/6.6	2	8,6 / 3.4	60 / 24"	1.2 / 48"	2,3	5.0
L830-3	TA065666-xx	65	6.6/6.6	2	8,6 / 3.4	60 / 24"	1.2 / 48"	2,4	5.25
L830-4	TA10066D-xx	100	6.6/6.6	3	8,9 / 3.5	60 / 24"	1.2 / 48"	3,5	7.7
L830-5	TA100266-xx	100	20/6.6	3	8,9 / 3.5	60 / 24"	1.2 / 48"	3,6	8.0
L830-6	TA200666-xx	200	6.6/6.6	4	9,1 / 3.6	60 / 24"	1.2 / 48"	4,9	10.8
L830-7	TA200266-xx	200	20/6.6	4	9,1 / 3.6	60 / 24"	1.2 / 48"	4,9	10.8
L830-8	TA300626-xx	300	6.6/20	4	11,4 / 4.5	60 / 24"	1.2 / 48"	6,9	15.1
L830-9	TA300226-xx	300	20/20	4	11,4 / 4.5	60 / 24"	1.2 / 48"	7,7	17
L830-10	TA300666-xx	300	6.6/6.6	4	11,4 / 4.5	60 / 24"	1.2 / 48"	7,2	15.8
L830-11	TA300266-xx	300	20/6.6	4	11,4 / 4.5	60 / 24"	1.2 / 48"	7,9	17.5
L830-12	TA500626-xx	500	6.6/20	4	12,5 / 4.9	60 / 24"	1.2 / 48"	8,0	17.6
L830-13	TA500226-xx	500	20/20	4	12,5 / 4.9	60 / 24"	1.2 / 48"	8,4	18.5
L830-14	TA500666-xx	500	6.6/6.6	4	12,5 / 4.9	60 / 24"	1.2 / 48"	8,0	17.6
L830-15	TA500266-xx	500	20/6.6	4	12,5 / 4.9	60 / 24"	1.2 / 48"	8,4	18.5
L830-16	TA010666-xx	10/15	6.6/6.6	1	6,6 / 2.6	60 / 24"	1.2 / 48"	1,30	2.88
L830-17	TA025666-xx	20/25	6.6/6.6	1	7,8 / 3.1	60 / 24"	1.2 / 48"	1,45	3.20
L830-18	TA150666-xx	150	6.6/6.6	3	8,9 / 3.5	60 / 24"	1.2 / 48"	3,6	8.0
L830-19	TA150266-xx	150	20/6.6	4	9,1 / 3.6	60 / 24"	1.2 / 48"	4,9	10.8

* All FAA certified transformers are BAA compliant

xx - suffix : - 01 "Tennis Ball" FAA L823 Style 8 " Used on frangible coupling light fixtures"

-10 "Straight" FAA L823 ,Style 7



Series Isolating Transformers



Airport Equipment
Qualified to :
- FAA Specification
AC 150/5345-47
- IEC 61823



FAA SPECIFICATION L 831 50 Hz *

FAA DESIGNATION	Catalog no.	Rated Watts	Pri. / Sec. Amps	Figure (See Page 8)	T Dim. (cm/in.)	Primary Lead Length (cm/in.)	Sec. Lead Length (m/in.)	Weight (Kg.)	Weight (Lb)
L831-1	TA045665-xx **	30/45	6.6/6.6	2	8,6 / 3.4	60 / 24"	1.2 / 48"	2,4	5.2
L831-2	TA045265-xx	30/45	20/6.6	2	8,6 / 3.4	60 / 24"	1.2 / 48"	2,3	5.0
L831-3	TA065665-xx **	65	6.6/6.6	2	8,6 / 3.4	60 / 24"	1.2 / 48"	2,5	5.5
L831-4	TA10066D-xx **	100	6.6/6.6	3	8,9 / 3.5	60 / 24"	1.2 / 48"	3,3	7.7
L831-5	TA100265-xx	100	20/6.6	3	8,9 / 3.5	60 / 24"	1.2 / 48"	3,6	8.0
L831-6	TA200665-xx **	200	6.6/6.6	4	9,9 / 3.9	60 / 24"	1.2 / 48"	5,6	12.40
L831-7	TA200265-xx	200	20/6.6	4	9,9 / 3.9	60 / 24"	1.2 / 48"	5,9	13.00
L831-8	TA300625-xx	300	6.6/20	4	11,4 / 4.5	60 / 24"	1.2 / 48"	6,9	15.1
L831-9	TA300225-xx	300	20/20	4	11,4 / 4.5	60 / 24"	1.2 / 48"	7,7	17
L831-10	TA300665-xx **	300	6.6/6.6	4	12,5 / 4.9	60 / 24"	1.2 / 48"	7,9	17.5
L831-11	TA300265-xx	300	20/6.6	4	11,4 / 4.5	60 / 24"	1.2 / 48"	7,9	17.5
L831-12	TA500625-xx	500	6.6/20	4	12,5 / 4.9	60 / 24"	1.2 / 48"	7,7	17.0
L831-13	TA500225-xx	500	20/20	4	12,5 / 4.9	60 / 24"	1.2 / 48"	8,4	18.5
L831-14	TA500665-xx	500	6.6/6.6	4	12,5 / 4.9	60 / 24"	1.2 / 48"	8,5	18.7
L831-15	TA500265-xx	500	20/6.6	4	12,5 / 4.9	60 / 24"	1.2 / 48"	8,5	18.7
L831-16	TA010665-xx	10/15	6.6/6.6	1	6,6 / 2.6	60 / 24"	1.2 / 48"	1,40	3.04
L831-17	TA025665-xx	20/25	6.6/6.6	1	7,8 / 3.1	60 / 24"	1.2 / 48"	1,45	3.20
L831-18	TA150665-xx **	150	6.6/6.6	4	9.1 / 3.6	60 / 24"	1.2 / 48"	4,8	10.5
L831-19	TA150265-xx	150	20/6.6	4	9.1 / 3.6	60 / 24"	1.2 / 48"	4,9	10.8

* All FAA certified transformers are BAA compliant

** In the catalog # denotes - IEC certified product by third party (ETL-Intertek)

xx - suffix : - 01 "Tennis Ball" FAA L823 Style 8 " Used on frangible coupling light fixtures"

-10 "Straight" FAA L823 ,Style 7



Series Isolating Transformers



Airport Equipment
Qualified to:
-C22.2 No. 180-M
Series Isolating
Transformers
for Airport Lighting

CSA CERTIFIED TRANSFORMERS (Canada)- With lay-in ground post



CS058* : Not CSA certified : Market demand of this product does not justify the



CSA certification cost.

Catalog no.	Rated Watts	Pri. / Sec. Amps	Figure (See Pg 9)	T Dim. (cm/in.)	Primary Lead Length (cm/in.)	Secondary Lead Length (m/in.)	Weight (Kg.)	
CTAG010666-xx	10/15	6.6/6.6	1	6,6 / 2.6	60 / 24"	1.2 / 48"	1,30	2.88
CTAG025666-xx	20/25	6.6/6.6	1	7,8 / 3.1	60 / 24"	1.2 / 48"	1,45	3.20
CTAG045666-xx	30/45	6.6/6.6	2	8,6 / 3.4	60 / 24"	1.2 / 48"	2,4	5.2
CTAG04566D-xx	30/45	6.6/6.6	3	8,9 / 3.5	60 / 24"	1.2 / 48"	3,1	6.9
CTAG065666-xx	65	6.6/6.6	2	8,6 / 3.4	60 / 24"	1.2 / 48"	2,4	5.2
CTAG10066D-xx	100	6.6/6.6	3	8,9 / 3.5	60 / 24"	1.2 / 48"	3,3	7.7
CTAG150666-xx	150	6.6/6.6	4	9,1 / 3.6	60 / 24"	1.2 / 48"	4,9	10.8
CTAG200666-xx	200	6.6/6.6	4	9,1 / 3.6	60 / 24"	1.2 / 48"	4,9	10.8
CTAG250626-xx	200	6.6/20	4	9,9 / 3.9	60 / 24"	1.2 / 48"	5,6	12.4
CTAG300666-xx	300	6.6/6.6	4	11,4 / 4.5	60 / 24"	1.2 / 48"	7,1	15.8
TAG500666-xx CS058*	500	6.6/6.6	4	12,5/4.9	60 / 24"	1.2 / 48"	9,0	19.1

xx - suffix : - 01 "Tennis Ball" FAA L823, Style 8 " Used on frangible coupling light fixtures"

- 10 "Straight" FAA L823, Style 7





Airport Equipment
 Qualified to
 FAA Specification
 AC 150/5345-47

Series Isolating Transformers

Figure 1 : 10-25 W (Super mini format)

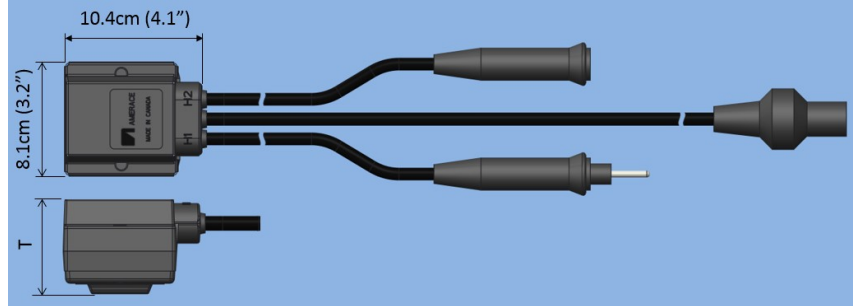

Figure 2 : 30-65 W (mini format)

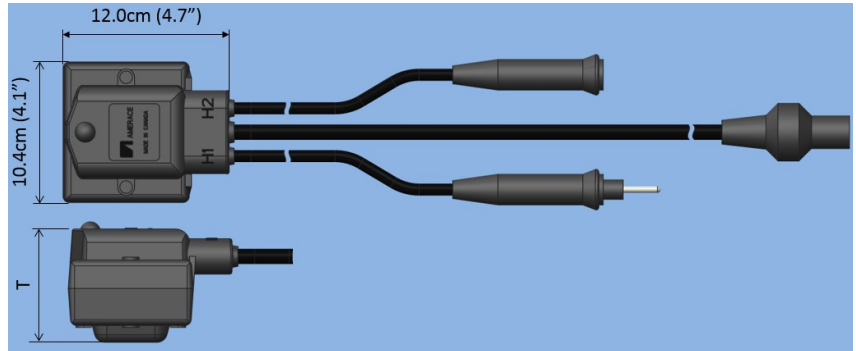

Figure 3 : 100-150 W (midi format)

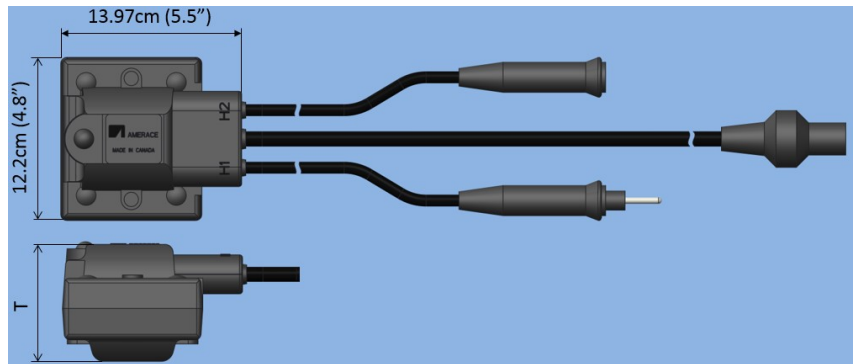
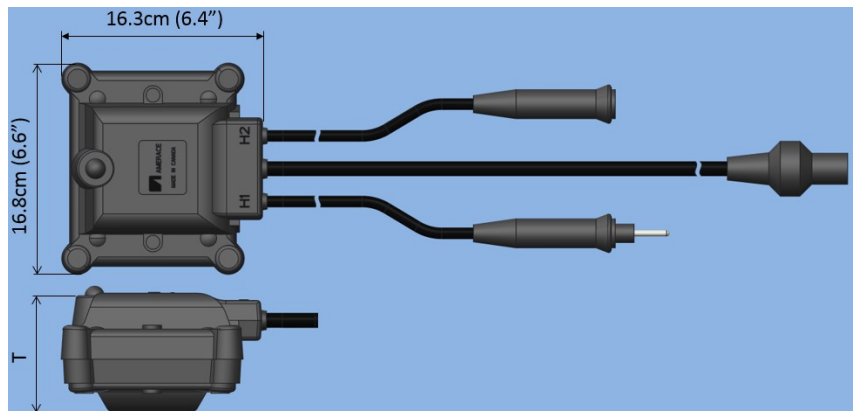

Figure 4 : 150- 500 W (maxi format)



Primary Connector Kits



Airport Equipment
Qualified to
FAA Specification
AC 150/5345-26

For Unscreened Cable

(FAA L823, Type 1, Class B, Style 3 Plug / Style 10 Receptacle)

ELECTRICAL RATING

25 Amps
5000 Volts Insulation

Weight

0.23Kg (0,5lb) - each kit
11,5 Kg (25Lb) - box of 50 kits

Construction

EPDM Rubber (Custom Blend)
Every housing is filled with silicone di-electric grease.

54 Super Kit (Standard L823 Enhanced Features)



54 Classic Kit (Standard L823 Features)



Suggested Crimping Tools

See Page 18 & 19

Note : - Classic kits are only available in sizes:

C4, D3, D4, D6, E3, E4, E6

- Size "B" supplied with an adapter sleeve (Super kit Only)

CATALOG NUMBER CODE

54 S



Model Number

54 S Super kit

- Added feature:

- ◆ Amer-Seal - interface
- ◆ Super-Seal - cable entrance
- ◆ Positive Lock/Grip - Contact

54 Classic

Receptacle Housing

- Outside diameter of cable:

- Select size code from [Table 1.](#)

Socket Contact Size

- Wire size:

- Select size code from [Table 2.](#)

Plug Housing / Pin Contact Size

- Outside diameter of cable:

- Select size code from [Table 1.](#)

Pin Contact Size

- Wire size:

- Select size code from [Table 2.](#)

Table 1 - Housing Size

Size Code	Cable Diameter			
	Metric		Imperial	
	Min.	Max.	Min.	Max.
C	5,0	6,6	0.195"	0.260"
C	6,4	8,4	0.250"	0.330"
D	8,1	10,9	0.320"	0.430"
Z	9,4	12,9	0.370"	0.507"
E	10,7	14,9	0.420"	0.585"
F	14,6	19,9	0.575"	0.785"

Table 2 Pin/Socket Contact Size

Size Code	Wire Size and Type			
	Concentric Stranded		Solid	
	mm ²	AWG	mm ²	AWG
6	4-6	10-12	4-6	8-10
4	10	8	10	6
3	16	6	16	4
2	-	4	-	-
1		2		



Airport Equipment
Qualified to
FAA Specification
AC 150/5345-26

Primary Connector Kits

For Screened Cable

Electrical Rating

25 Amps
5000 Volts Insulation

Weight

0.23Kg (0.5lb) - each kit
12 Kg (26.5Lb) - box of 50 kits

Construction

EPDM Rubber –Custom Blend
Every kit filled with silicone dielectric grease

Suggested Crimping Tools

See page 18

(Ref: FAA L823 Type 1, Class B, Style 3 Plug, Style 10 Receptacle)

52Super B Kit : Tin Pated Ground Lead



52Super I Kit : Insulated Ground Lead



CATALOG NUMBER CODE

52S

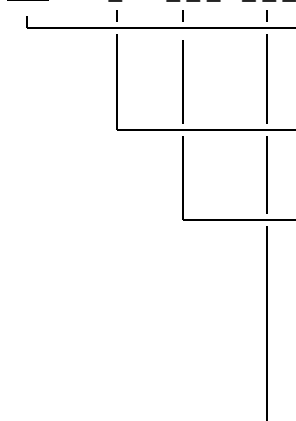

Model Number

52S Connecting screened primary cable to Amerace encapsulated transformers or creating a separate splice in screened primary cable.

Earth Wire

B - Bare - Tin plated Copper
I - Insulated

Receptacle Housing/Socket Contact Size

- Outside diameter of jacket:

- Select size code from [Table 1](#).

- Outside diameter of Insulation:

- Select size code from [Table 1](#).

- Wire size:

- Select size code from [Table 2](#).

Plug Housing / Pin Contact Size

- Outside diameter of jacket:

- Select size code from [Table 1](#).

- Outside diameter of insulation

- Select size code from [Table 1](#).

- Wire size:

- Select size code from [Table 2](#).

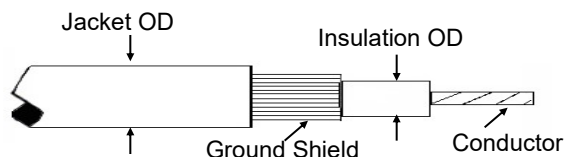

Table 1 - Housing Size

Size Code	Cable Diameter			
	Metric		Imperial	
	Min.	Max.	Min.	Max.
C	6,4	8,4	0.250"	0.330"
D	8,1	10,9	0.320"	0.430"
E	10,7	14,9	0.420"	0.585"
F	14,6	19,9	0.575"	0.785"

Table 2 Pin/Socket Contact Size

Size Code	Wire Size and Type			
	Concentric Stranded		Solid	
	mm ²	AWG	mm ²	AWG
6	4-6	10-12	4-6	8-10
4	10	8	10	6
3	16	6	16	4
2	-	4	-	-





Airport Equipment
Qualified to
FAA Specification
AC 150/5345-26

Secondary Connector Kits

(FAA L823, Type II Class B)

Used for field assembly of extension cords or repair of connectors.

90 Series Plug
(FAA L823 Style 4)

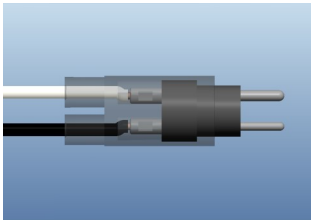

90 Series Receptacle
(FAA L823 Style 11)

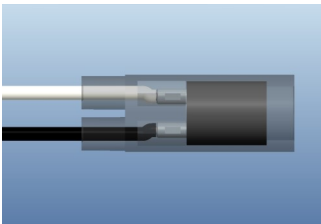

91 Series Plug
(FAA L823 Style 5)

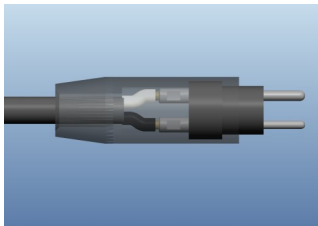

91 Series Receptacle
(FAA L823 Style 12)

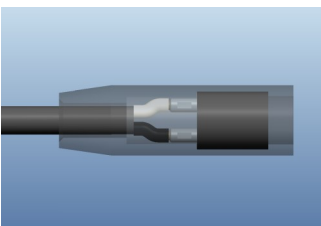

Ordering Instructions

Amerace® connector kit model numbers make it easy to select the right product for your specific application.

Follow the chart to the right.

Example

Order catalog number 90P-B6 for a secondary connector kit for a plug (male) termination on 2 single conductors with an outside diameter over insulation between 5 mm² (.195") and 6,6 mm² (.260") and wire size of 4 mm² (10-12 AWG) stranded or 6 mm² (8-10 AWG) solid.

Weight

0,06 kg (.14lb) - each kit
6,5 kg (14lb) - box of 100 kits

Suggested Crimping Tools

See page 18.

Electrical Rating

20A
600V between contacts
1500V to earth

CATALOG NUMBER CODE

90 _ - _ _

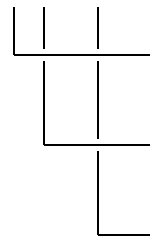

Model Number

- 90 for terminating 2 single conductors
- 91 for terminating 2 core cable

Configuration

- P – Plug (male) connector
- R – Receptacle (female) connector

Outside diameter over Insulation (90 Series) or Jacket (91 Series)

Select size code from Table 1.

Wire size

Select size code from Table 2.

Table 1 (Housing Size)

Size Code	Insulation or Jacket Diameter				Applicable to Kit Models
	Metric		Imperial		
	Min.	Max	Min.	Max	
S	3,0	4,0	0.120"	0.160"	90P, 90R
A	3,9	5,5	0.155"	0.205"	90P, 90R
B	5,0	6,6	0.195"	0.260"	90P, 90R
C	6,4	8,4	0.250"	0.330"	90P, 90R
D	8,1	10,9	0.320"	0.430"	91P, 91R
E	10,7	14,9	0.420"	0.585"	91P, 91R
F	14,6	19,9	0.575"	0.785"	91P, 91R

Table 2 (Contact Size)

Size Code	Wire Size and Type			
	Concentric Stranded		Solid	
	mm ²	AWG	mm ²	AWG
8		14-16		12-14
6	2,5 - 4	10-12	6	8-10
4	6	8	10	6



Primary Cable Assemblies



Airport Equipment
Qualified to
FAA Specification
AC 150/5345-26

(FAA L823, Type 1, Class A, Style 2 Plug / Style 9 Receptacle)

- All connectors are molded on the cable for strong water-proof joints.
- 25 amps
- 5000 Volts to earth
- Every cable assembly is continuity checked prior to shipment
- Cable assemblies are conveniently coiled and shipped in boxes or fiber drums (contact factory for reels or other arrangements.)

CATALOG NUMBER CODE

"Standard" Connector

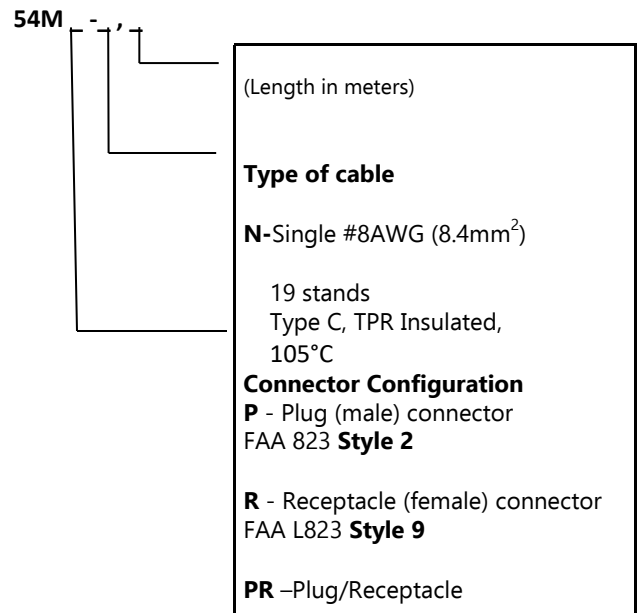
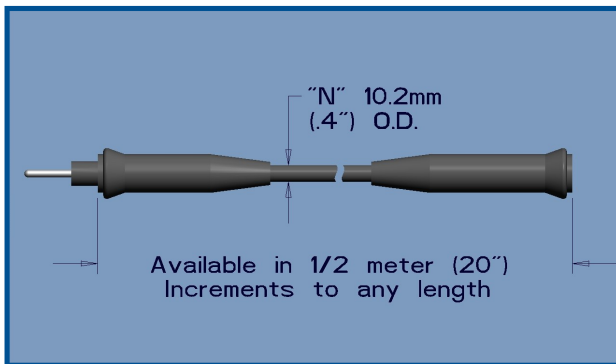

"T" Connector

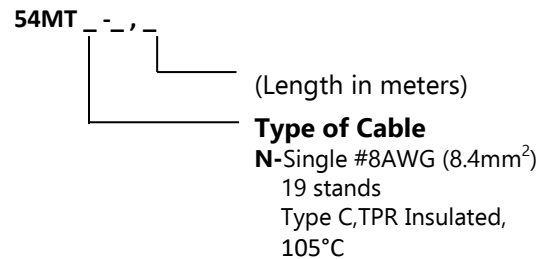
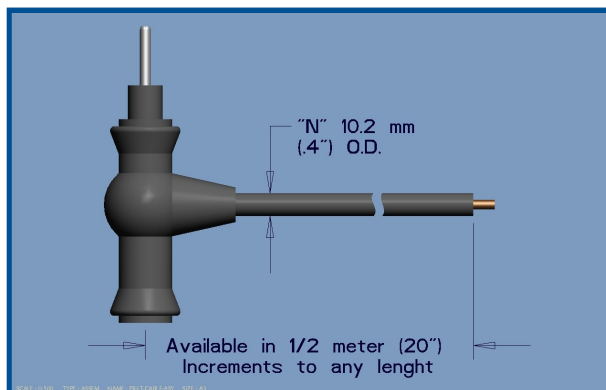

Secondary Cable Assemblies



Airport Equipment
Qualified to
FAA Specification
AC 150/5345-26

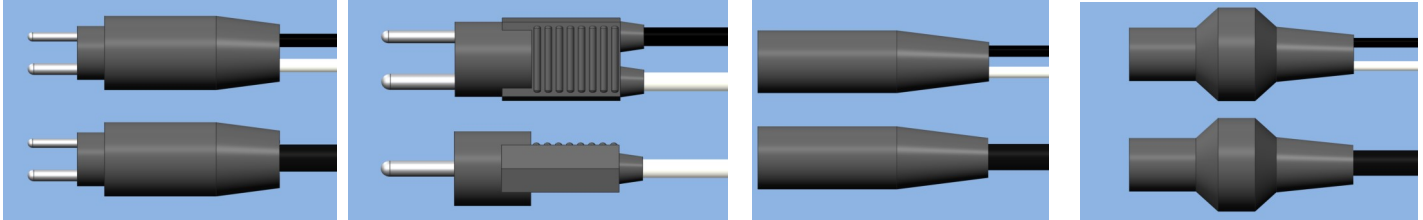

Style 1

Style 6

Style 7

Style 8

- Water proof connectors and cables/wires
- Submersible, Buriable (earth)
- Insulation to Earth rating 1500V
- Current Rating 20Amps
- Teflon Wires certified to : UL1199 and CSA1 A/B

(FAA L823, Type 1, Class A, Style 1/6 Plug / Style 7/8 Receptacle)

CATALOG NUMBER CODE

95M - - - - , - -

length in 1/2 meter increments

- P** FAA L823 Style 1 Plug Lead
- P6** FAA L823 Style 6 Plug Lead (all single wires and only "V" 2 core cable)
- R7** FAA L823 Style 7 Receptacle Lead
- R8** FAA L823 Style 8 Receptacle Lead
- PR7** FAA L823 Style 1/7 Plug/Receptacle Lead
- PR8** FAA L823 Style 1/8 Plug/Receptacle Lead
- P6R7** FAA L823 Style 6/7 Plug/Receptacle Lead
- P6R8** FAA L823 Style 6/8 Plug/Receptacle Lead

	Wire Size			Temp Rating (°C)	Insulation Material	Voltage Rating (V)	OD	
	Code	AWG	metric (mm ²)				Inch	mm
2 Core Cable	I	2/16	1,3	105	TPE	600	0.37	9,4
	V	2/16	1,3	105	TPE	300	0.316	8,026
	B	2/14	1,2	105	TPE	600	0.398	10,11
	U	2/13	2,6	105	TPE	600	0.41	10,41
	G	2/12	3,3	105	TPE	600	0.5	12,7
Single Wire	H	16	1,3	105	TPE	600	0.125	3,2
	L	16	1,3	200	Teflon	600	0.096	2,44
	K	14	2,1	200	Teflon	600	0.114	2,90
	F	12	3,3	105	TPE	600	0.185	4,7

Voltage Transformers

- Used in parallel circuits see diagram on page 16.
- Submersible, Buriable (Earth)
- Connect using standard FAA L823 type connectors (page 12/13)
- Allow step down of line voltage for standard airfield bulbs (6.6 amp), or for other standard bulbs such as automotive (12V), or 120/240 volt

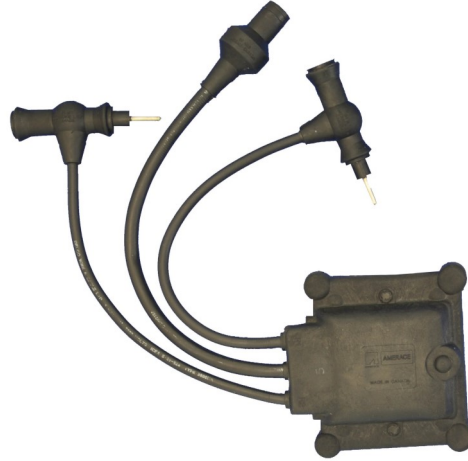

Catalog Number	Rated Watts	Pri./Sec. Voltage Rating	Fig.	'T' Dim cm/in.	Lead Length		Approx. Ship Wt.	
					Primary	Secondary	(Kg)	(Lbs)
VTA045P120S6.8-01	45	120/6.8	5	8,6/3.4	38cm 15"	38cm 15"	3,1	6.9
VTA045P240S6.9-01	45	240/6.9	5	8,6/3.4	38cm 15"	38cm 15"	3,1	6.9
VTA200P240S30.3-01	200	240/30.3	6	9,9/3.9	38cm 15"	38cm 15"	5,5	12.0
VTA300P240S45.5-01	300	240/45.5	6	11,4/4.5	38cm 15"	122cm (48")	6,6	14.5

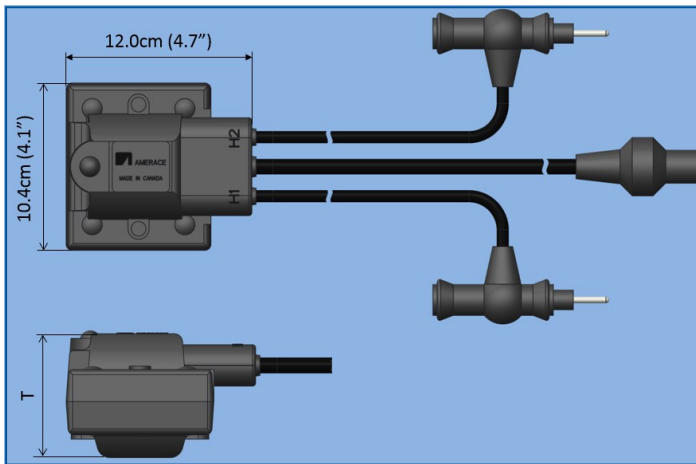

Figure 5 : 45 W (midi format)

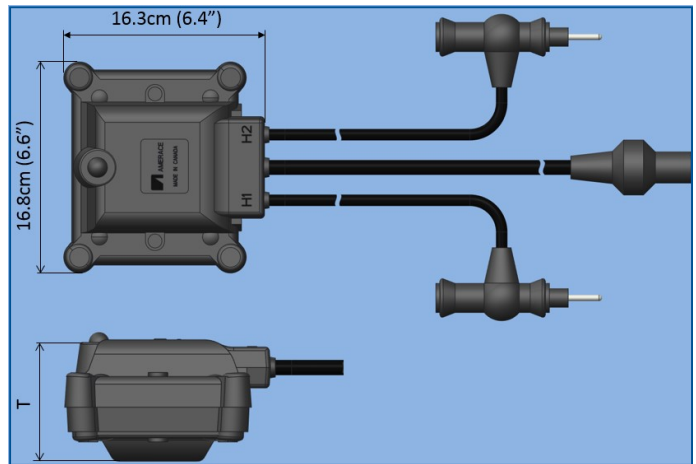
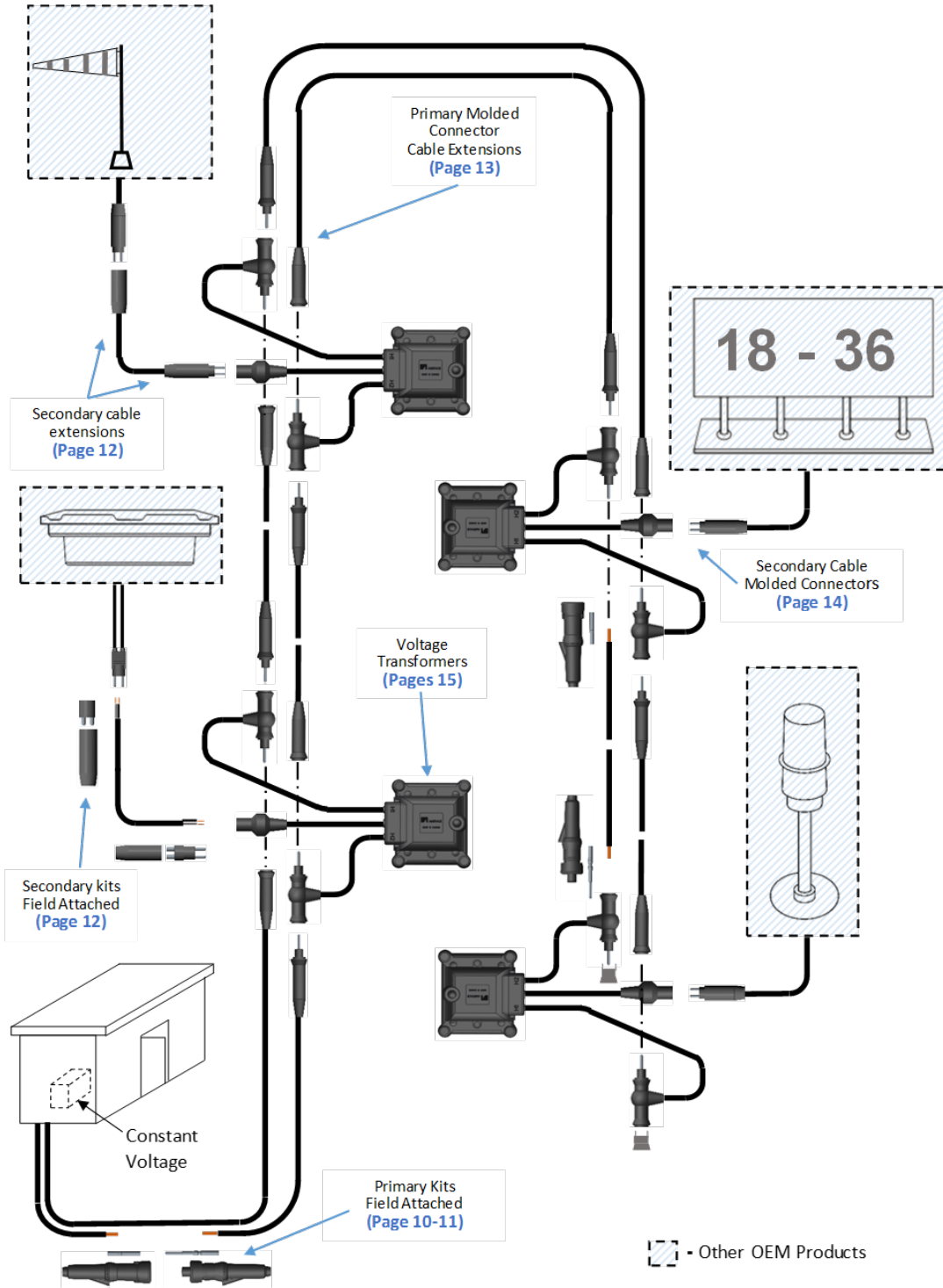

Figure 6 : 150– 500 W (maxi format)

Don't see what you want here?
Contact us with your requirement.

Product Index Guide for Typical AGL Parallel Circuit



Accessories



Wye Cable Assembly :

- Voltage rating : 600V ; Current Rating : 20Amps
- Insulation rating " 1500 V to ground
- Environment temperature -55°C (-67°F) to +65°C (+149°F)
- All connectors are molded on the cable for strong water tight joint
- Every cable assembly is continuity checked prior to shipment.
- F - Two individual #12 AWG (3,3mm²) thermoplastic insulated, water proof wires, O.D. 4,7mm (0.185")

1.0 To connect One transformer to Two light fixtures

96MPR7R7F -xx*



**96MP6R7R7F -xx*CS
(mini- customer Special)**



2.0 To connect Two transformer to One light fixture

96MPPR7F xx* CS



**96MP6P6R7F -xx* CS
(mini- Customer Special)**



xx* - denotes length of extension

Suggested Tools

(For Field Attached Connector Kits)



Suggested Crimping Tools for use with AMERACE® Connector Kits						
Amerace Contact Size	Wire Size		Available Tools	Crimps		Application
	mm2	AWG		#	Location	
8	2 Stranded 3 Solid	16 Stranded 14 Stranded 14 solid 12 solid	T&B WT 111M "AB" Groove Channel Lock #909 * Burndy Y 14MF	2	Rotate the second crimp 90° from the first	Primary Only Primary & Secondary** Primary & Secondary**
6	4 Stranded 6 Solid	12 Stranded 10 Stranded 10 solid 8 solid	T&B WT 111M "C" Groove Channel Lock #909 * Burndy Y 14MF	2	Rotate the second crimp 90° from the first	Primary Only Primary & Secondary** Primary & Secondary**
4	6 Stranded 10 Solid	8 Stranded 6 solid	T&B TBM25S 'Red' Groove* T&B TBM45S 'Red' Groove Channel Lock #909 ** Burndy Y 14MF Burndy MR4C '8' Groove Nico Press 31 'E' Groove	2	Rotate the second crimp 90° from the first	Primary Only Primary Only Primary & Secondary** Primary & Secondary** Primary Only Primary Only
3	10 Stranded 16 Solid	6 Stranded 4 solid	T&B TBM25S 'Blue' Groove T&B TBM45S 'Blue' Groove Burndy MR4C '6' Groove Nico Press 41 'G' Groove	2	Rotate the second crimp 90° from the first	Primary Only Primary Only Primary Only Primary Only
2	16 Stranded	4 Stranded	Nico Press 31 'J' Groove	2	Rotate the second crimp 90° from the first	Primary Only

* Factory Modified.

** Secondary one crimp only.

*** The TBM25S is obsolete and no longer available for sale.



Advantage Tool Kit

Select the tool kit that's right for your application

Tools to connect Primary and Secondary L-823 Connector Kits to Cable

5
TOOL KITS
available

TOOLS
ALSO SOLD
SEPARATELY

	TBM43S	Knipex 95 11 200	Knipex 87 01 250	Knipex 16 30 135 SB*	Greenlee AM25*	Channel Lock #909 M	Knipex 12 12 06
Tool Kits	RATCHETING CRIMPER	CABLE SHEARS	PLIERS SELF LOCKING	DISMANTLING TOOL	DISMANTLING TOOL	CRIMP TOOL CHANNEL M	INSULATION STRIPPER
Advantage	✓	✓	✓	✓	✓	✓	✓
54 Super (unshielded cable)	✓	✓	✓				
52 Super (shielded cable)	✓	✓	✓	✓			
52 Super China Only	✓	✓	✓	✓	✓		
90/91 Secondary						✓	✓

*comes with an addl replacement blade

*comes with an addl replacement blades X2

AMERACE AIRPORT LIGHTING

Guide to FAA L823 Connectors

<http://www.amerace.com>

FAA DESIGNATIONS IN RED

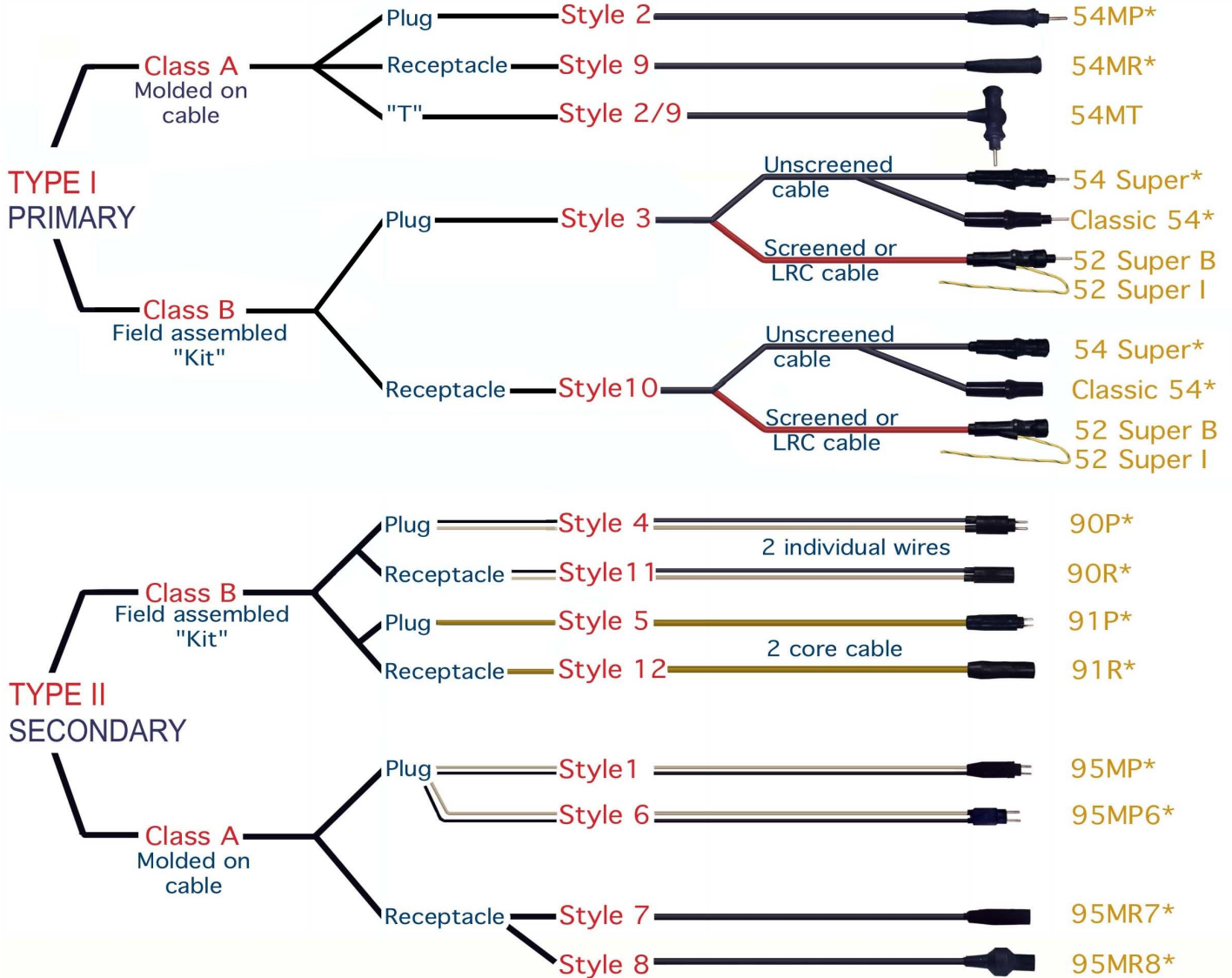

The * symbol indicates the connector is certified by ETL, and listed in the FAA AC 150/5345-IV "Approved Airport Equipment".

This list is updated monthly and may be downloaded from:

http://www.faa.gov/airports/resources/advisory_circulars/

AMERACE

Guide to FAA Style Airfield Lighting Connectors

FAA L823 TYPE I (PRIMARY)

Single Conductor, 25 Amps, 5000 Volts to Earth

PLUG, Type I, Class A, Style 2

RECEPTACLE, Type I, Class A, Style 9

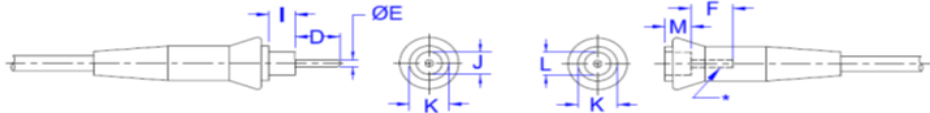

DIMENSION	INCHES	CENTIMETERS
D	1.062 ±.015	2.697 ±.038
E	0.186 ±.001	0.472 ±.003
F	1.080 Min	2.743 Min
I	0.593 +.015, -.000	1.506 +.038, -.000
J	0.604 +.010, -.000	1.534 +.025, -.000
K	0.937 +.000, -.031	2.380 +.000, -.079
L	0.573 ±.010	1.455 ±.025
M	0.608 +.000, -.015	1.544 +.000, -.038

* Metal socket shall be recessed not more than 1/8 inch (0.318 cm) below inside face of receptacle and before splitting shall have an I.D. of 0.188±0.001 inch (0.478±0.003cm).

CLASS A

Factory Fabricated Cable Assemblies - Series 54M

Single Wire Extension

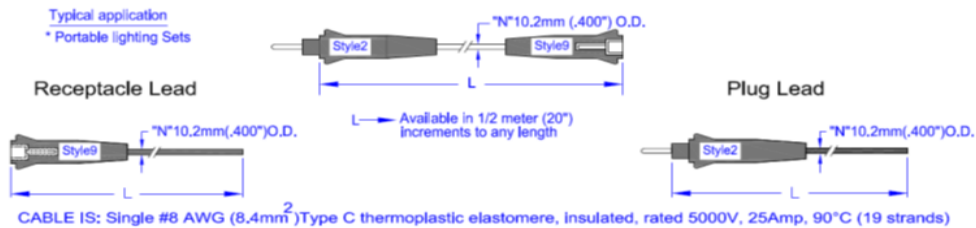

CLASS B

Field Applied Connector Kits - Series 52/54

Series 54 for Unscreened Cable Kit Contents



Cut-away of completed assembly



Series 54 Super for Unscreened Cable Kit Contents



Cut-away view

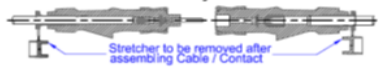

Completed Assembly



Series 52 Super for Screened Cable Kit Contents

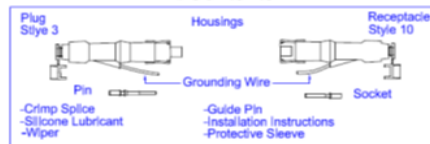

(NON FAA) Cut-away view



Completed Assembly



DRAWING No.	DATE	REV
S019	02/05/2016	5

AMERACE

Guide to FAA Style Airfield Lighting Connectors

FAA L823 TYPE II (SECONDARY)

Two Conductor, 20 Amps, 600 Volts Between Conductors, 1500 Volts to Earth

(a) PLUG, Type II, Class A, Style 1

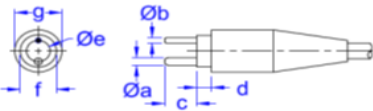

(b) RECEPTACLE, Type II, Class A, Style 7

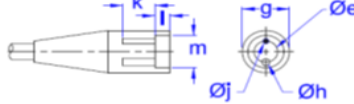

(c) RECEPTACLE, Type II, Class A, Style 8

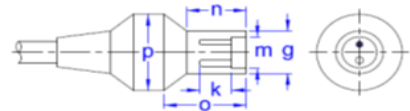

(d) PLUG, Type II, Class A, Style 6

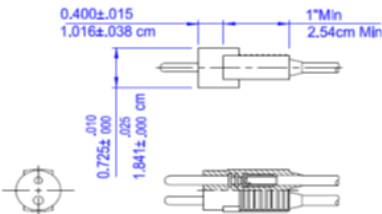

DIMENSION	INCHES	CENTIMETERS	REFERENCE
a	0.155 ±.001	0.394 ±0.003	Connector for white wire
b	0.124 ±.001	0.315 ±0.003	Connector for black wire
c	0.625 ±.015	1.587 ±0.038	Plug pin
d	0.343 +.031, -.000	0.871 +0.079, -.000	Plug
e	0.435 ±.010	1.105 ±0.025	Plug, Receptacle
f	0.725 +.010, -.000	1.841 +0.025, -.000	Plug
g	1.000 +.000, -.031	2.540 +.000, -.079	Plug, Receptacle
h	0.157 ±.001	0.399 ±0.003	Socket dia. before splitting connector for white wire
j	0.126 ±.001	0.320 ±0.003	Socket dia. before splitting connector for black wire
k	0.641 Min	1.628 Min	Depth of socket includes .125" (.318cm) recess below inside face of receptacle
l	0.358 +.000, -.015	0.909 +.000, -.038	Receptacle
m	0.694 ±.010	1.763 ±0.025	Receptacle
n	1.125 ±.031	2.857 ±0.079	Receptacle
o	1.500 ±.031	3.810 ±0.079	Receptacle
p	1.750 ±.031	4.445 ±0.079	Receptacle

CLASS A

Factory Fabricated Cable Assemblies - Series 95M

Two Wire Extensions



Cable Pigtail

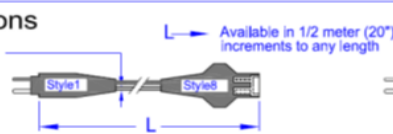
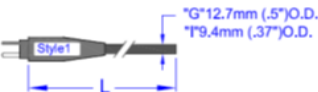

Two Wire Pigtail

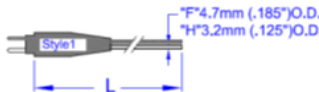

Cable Extensions

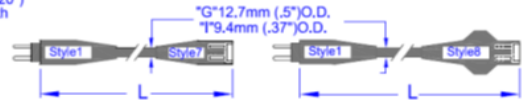

Cable Receptacle Lead

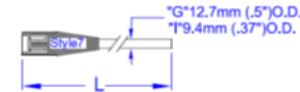

Cable Receptacle Lead



F is two individual #12 AWG (3.3mm²) thermoplastic elastomer insulated waterproof wires, rated 600V, 20Amp, 90°C
H is as *F* but #16 AWG (1.3mm²)

G is 2/12 AWG (3.3mm²) thermoplastic insulated waterproof cable with overall jacket, rated 600V to earth, 1500V between wires, 20Amp, 90°C
I is as *G* but 2/16 AWG (1.3mm²)

CLASS B

Field Applied Connector Kits - Series 90/91

Series 91 for Two Core Cable

Kit Contents

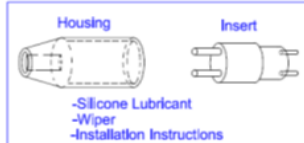

MODEL 91P

Kit Contents

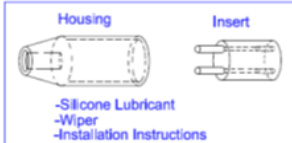

MODEL 91R

Kit Contents

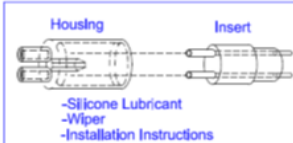

MODEL 90P

Kit Contents

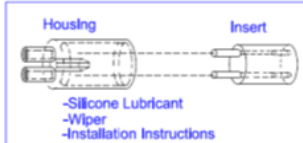

MODEL 90R

Cut-away of completed assemblies

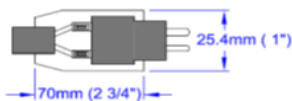

Style 5

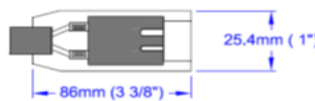

Style 12

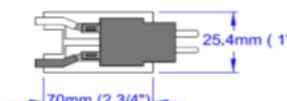

Style 4



Style 11

DRAWING No.	DATE	REV
S019	02/05/2016	5

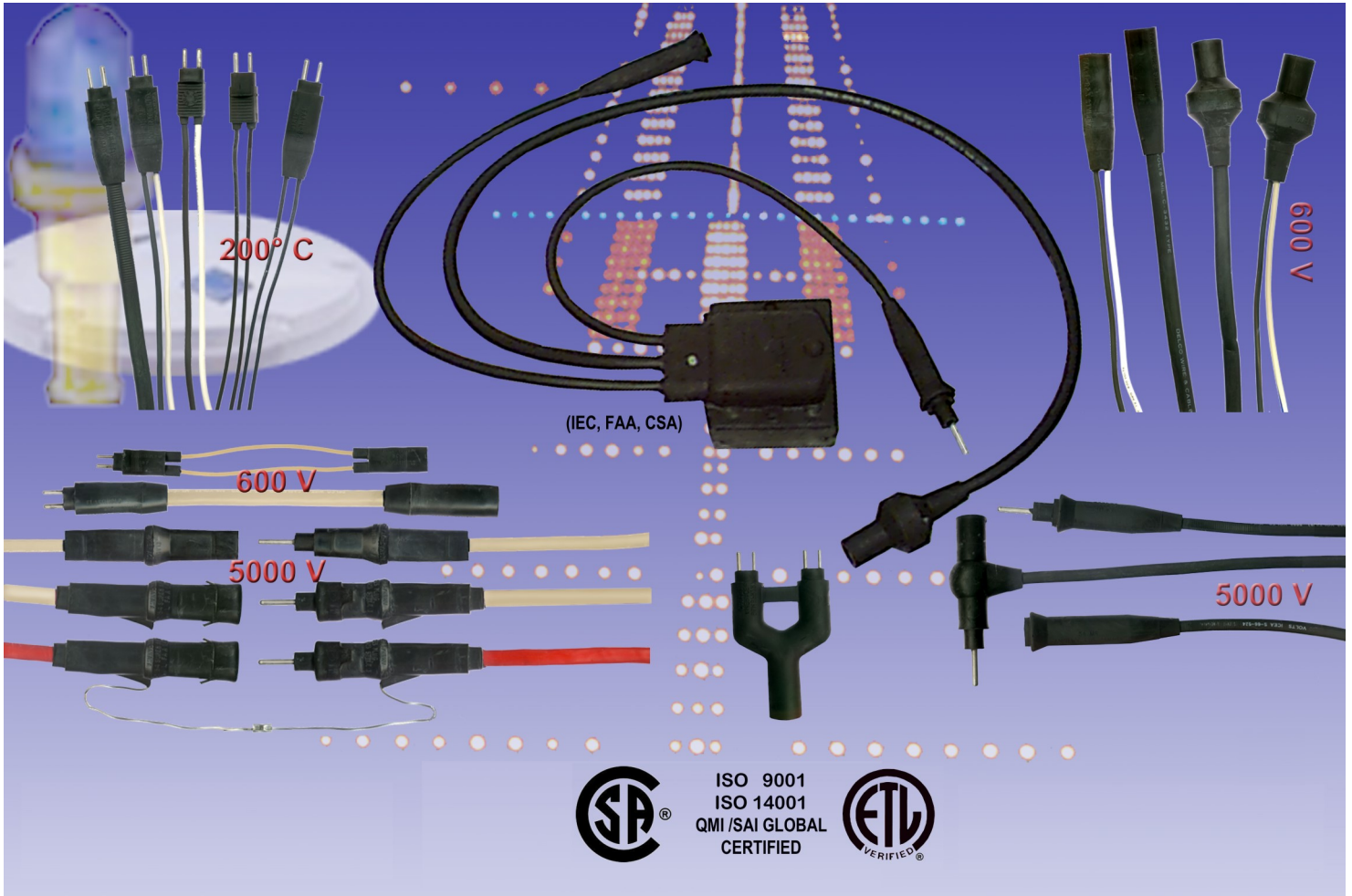

We manufacture products for airports around the world and supply them through selected original equipment manufacturers and specialized airfield lighting integrators.

For complete up-to-date information, technical data and other airfield lighting products please visit :

www.amerace.com

Contact information:

Sales Customer Service/Sales: +1 905 666-2251 ext. 232
Engineering: +1 905 635 7878

Thomas and Betts Ltd. All rights reserved.
Printed in Canada

Amerace 05-2018-R9

